

4

2" W PIPE

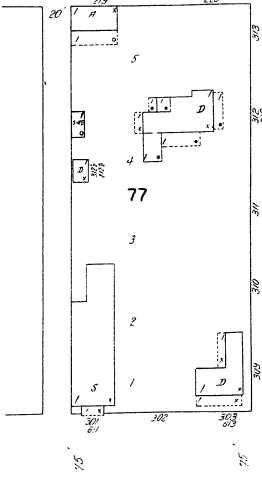

ENGLEWOOD

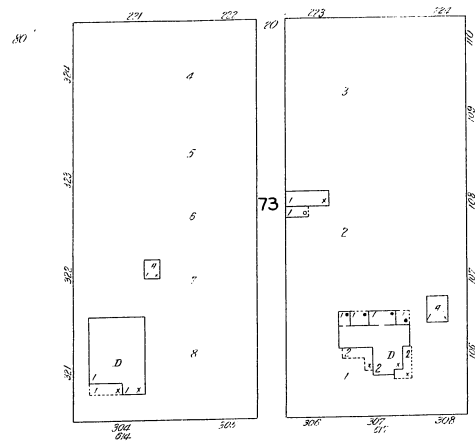

MORGAN

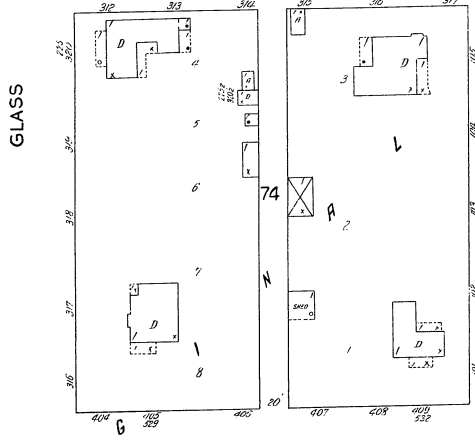

GLASS

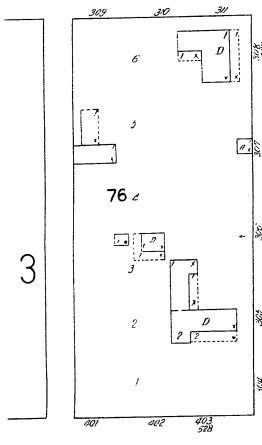

2" W PIPE

2" W PIPE

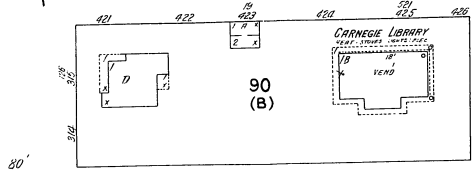
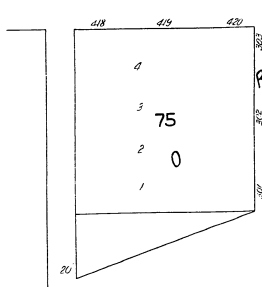

CARNEGIE LIBRARY

RAILROAD RESERVATION

(REV)

4

80'

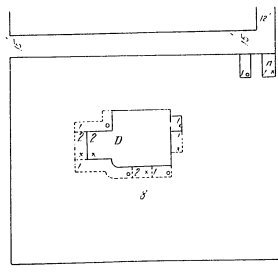

MAR. 1927
FRANKLIN
TEX.

BAXTER

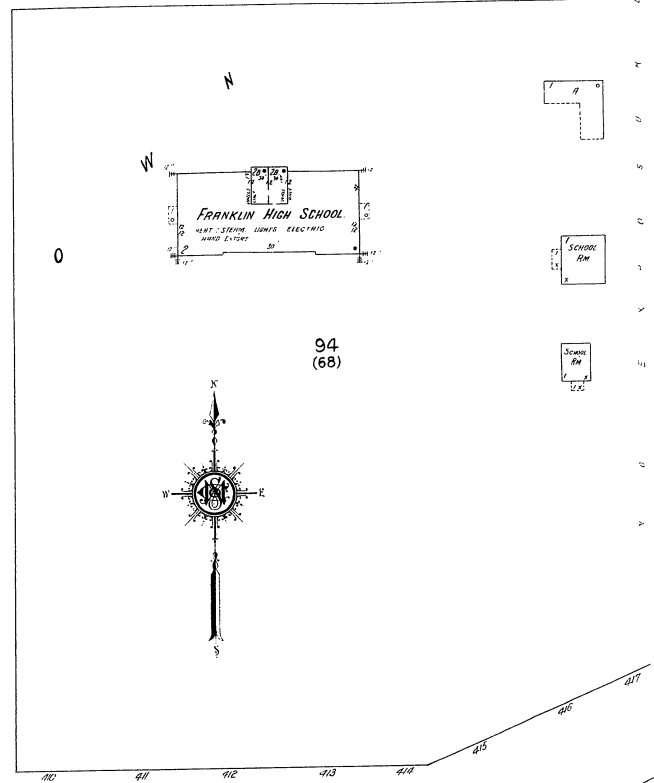

FRANKLIN HIGH SCHOOL



OWENSVILLE

(BECHERD)

80'

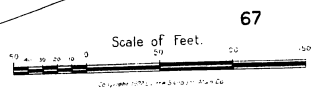

67